

**GR881 (8K x 8)
NON-VOLATILE RAM**

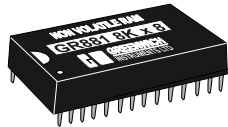

ABSOLUTE MAXIMUM RATINGS

Symbol	Min	Max	Units
Vdd	-0.3	7.0	Volts
Vi/o	-0.3	Vdd +0.3	Volts
Temp	-20	+70	deg. C

OPERATING CONDITIONS

Symbol	Min	Typ	Max	Unit
Vdd	4.75	5.0	5.5	Volts
Vin (1)	2.2		Vdd+0.3	Volts
Vin (0)	-0.3		0.8	Volts
Iin (any other pin)	-1.0		+1.0	µA
Vout (1)(Iout = -1mA)	2.4			Volts
Vout (0)(Iout = +2mA)			0.4	Volts
Idd (Active)		30		mA
Idd (Deselected)		1.0		mA
Tcycle			100	nS
Cin (any pin)		10		pF

DESCRIPTION

The GR881 is a 8192 word by 8 bits (8K x 8) non-volatile CMOS Static Ram, fabricated from advanced silicon gate CMOS technology and a high reliability lithium power cell. The pin-out of the GR881 conforms to the JEDEC standards and is fully compatible with normal static RAM.

The power down circuit is fully automatic and is referenced at 4.5 volts. At this point the GR881 is write protected by an internal inhibit function for Data Protection and the memory contents are retained by the lithium power source.

Power down is very fast, this being essential for data integrity, taking a maximum of 15 µS (15 microseconds) to power down from 5 volts to 0 volts. This is much faster than system power failure conditions. Therefore there are no special conditions required when installing the GR881.

The GR881 can, without external power, retain data almost indefinitely. The limiting factor will be the shelf life of the lithium cell, which is typically ten years. It is possible that this figure may be extended in view of the extremely light duty imposed upon the cell.

APPLICATION

When powered down, the GR881 is transportable and data can be moved from system to system, this makes it ideal for program development, data collection in data loggers, program changes in process control, automation and robotics and user definable lookup tables, etc.

DISPOSAL INSTRUCTIONS

Do not dispose of non-volatile memory devices by incineration or crushing. Devices may be returned carriage paid to Greenwich Instruments Ltd., for disposal.

Greenwich Instruments Ltd.,
Meridian House, Park Road,
Swanley, Kent. BR8 8AH
Tele: 08700 505 404
01322 668 724
Fax: 08700 505 405

OPERATING MODE

CE	OE	WR	MODE	OUTPUT	Idd
H	X	X	Unsel.	Hi-Z	Standby
L	H	H	Unsel.	Hi-Z	Active
L	L	H	Read	Dout	Active
L	X	L	Write	Din	Active

PIN CONNECTIONS

NC	1	28
A12	2	27
A7	3	26
A6	4	25
A5	5	24
A4	6	23
A3	7	22
A2	8	21
A1	9	20
A0	10	19
D0	11	18
D1	12	17
D2	13	16
GND	14	15

PIN DESIGNATIONS

Pin	Function
A0-A12	Address I/P's
D0-D7	Data in/out
OE	Output Enable
CE ₁ CE ₂	Chip Enable
WR	Write Enable
Vdd	+5Volt Power
GND	Ground

DATA RETENTION OPERATING CONDITIONS

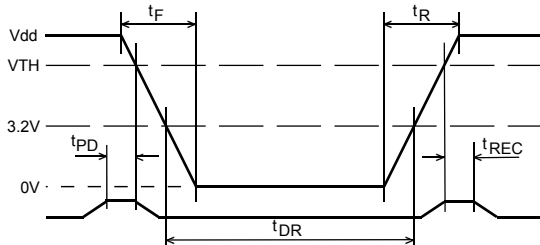

Symbol	Parameter	Min	Typ	Max	Units
Vdd	Operating supply voltage	4.75	5.0	5.50	Volts
VTH	Data retention voltage		4.5		Volts
tF	Vdd slew to 0V	15			µS
tR	Vdd slew 0V to 5.0V	15			µS
tREC	CE to O/P valid from power up			15	µS
tDR	Data retention time		10		Years
tPD	CE at Vin(1) before power down	0			µS

**GR881 (8K x 8)
NON-VOLATILE RAM**

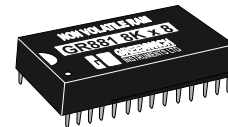

ABSOLUTE MAXIMUM RATINGS

Symbol	Min	Max	Units
Vdd	-0.3	7.0	Volts
Vi/o	-0.3	Vdd +0.3	Volts
Temp	-20	+70	deg. C

OPERATING CONDITIONS

Symbol	Min	Typ	Max	Unit
Vdd	4.75	5.0	5.5	Volts
Vin (1)	2.2		Vdd+0.3	Volts
Vin (0)	-0.3		0.8	Volts
Iin (any other pin)	-1.0		+1.0	µA
Vout (1)(Iout = -1mA)	2.4			Volts
Vout (0)(Iout = +2mA)			0.4	Volts
Idd (Active)		30		mA
Idd (Deselected)		1.0		mA
Tcycle			100	nS
Cin (any pin)		10		pF

DESCRIPTION

The GR881 is a 8192 word by 8 bits (8K x 8) non-volatile CMOS Static Ram, fabricated from advanced silicon gate CMOS technology and a high reliability lithium power cell. The pin-out of the GR881 conforms to the JEDEC standards and is fully compatible with normal static RAM.

The power down circuit is fully automatic and is referenced at 4.5 volts. At this point the GR881 is write protected by an internal inhibit function for Data Protection and the memory contents are retained by the lithium power source.

Power down is very fast, this being essential for data integrity, taking a maximum of 15 µS (15 microseconds) to power down from 5 volts to 0 volts. This is much faster than system power failure conditions. Therefore there are no special conditions required when installing the GR881.

The GR881 can, without external power, retain data almost indefinitely. The limiting factor will be the shelf life of the lithium cell, which is typically ten years. It is possible that this figure may be extended in view of the extremely light duty imposed upon the cell.

APPLICATION

When powered down, the GR881 is transportable and data can be moved from system to system, this makes it ideal for program development, data collection in data loggers, program changes in process control, automation and robotics and user definable lookup tables, etc.

DISPOSAL INSTRUCTIONS

Do not dispose of non-volatile memory devices by incineration or crushing. Devices may be returned carriage paid to Greenwich Instruments Ltd., for disposal.

Greenwich Instruments Ltd.,
Meridian House, Park Road,
Swanley, Kent. BR8 8AH
Tele: 08700 505 404
01322 668 724
Fax: 08700 505 405

OPERATING MODE

CE	OE	WR	MODE	OUTPUT	Idd
H	X	X	Unsel.	Hi-Z	Standby
L	H	H	Unsel.	Hi-Z	Active
L	L	H	Read	Dout	Active
L	X	L	Write	Din	Active

PIN CONNECTIONS

NC	1	28
A12	2	27
A7	3	26
A6	4	25
A5	5	24
A4	6	23
A3	7	22
A2	8	21
A1	9	20
A0	10	19
D0	11	18
D1	12	17
D2	13	16
GND	14	15

PIN DESIGNATIONS

Pin	Function
A0-A12	Address I/P's
D0-D7	Data in/out
OE	Output Enable
CE ₁ CE ₂	Chip Enable
WR	Write Enable
Vdd	+5Volt Power
GND	Ground

DATA RETENTION OPERATING CONDITIONS

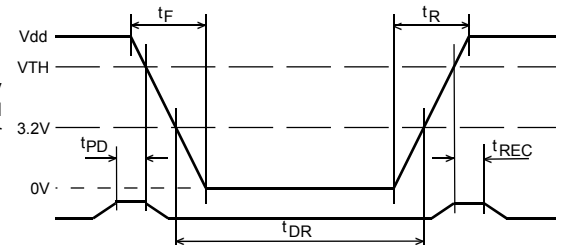

Symbol	Parameter	Min	Typ	Max	Units
Vdd	Operating supply voltage	4.75	5.0	5.50	Volts
VTH	Data retention voltage		4.5		Volts
tF	Vdd slew to 0V	15			µS
tR	Vdd slew 0V to 5.0V	15			µS
tREC	CE to O/P valid from power up			15	µS
tDR	Data retention time		10		Years
tPD	CE at Vin(1) before power down	0			µS

**GR881 (8K x 8)
NON-VOLATILE RAM**

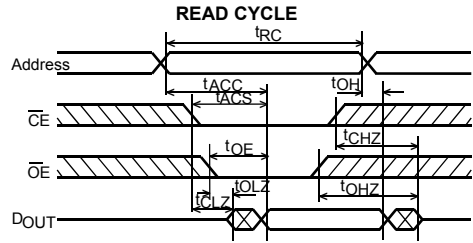

TIMING (nS-nano seconds)

Symbol	Parameter	Min	Max
t _{RC}	Read cycle time	100	
t _{ACC}	Access time		100
t _{ACS}	CE to output valid		100
t _{OE}	OE to output valid		40
t _{CLZ}	CE to output active	10	
t _{OLZ}	OE to output active	5	
t _{OH}	Output hold time	10	
t _{CHZ}	CE to output disable		30
t _{OHZ}	OE to output disable		20

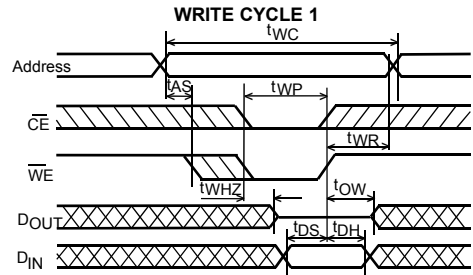

Write Cycle 100nS

Symbol	Parameter	Min	Max
t _{WC}	Write cycle time	100	
t _{WP}	Write pulse width	60	
t _{AS}	Address setup time	0	
t _{WR}	Write recovery time	0	30
t _{WHZ}	WR to output disable		30
t _{OW}	Output active from WR	10	
t _{DS}	Data setup time	40	
t _{DH}	Data HOLD TIME	0	

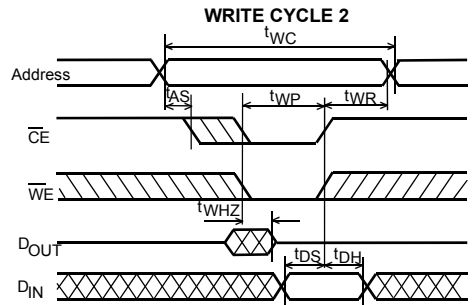

Notes

1. WE must be high during address transitions.
2. A Write occurs during the overlap of active CE and a low WE.
3. CE = CE1 and CE2
4. WE is high for a read cycle.

REPLACES 6264., 5565., etc.

DIMENSIONS (mm)

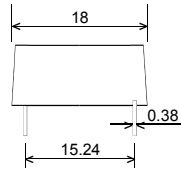
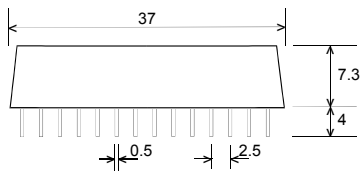

Greenwich Instruments Ltd., are continually developing their products and reserve the right to alter specifications without prior notice. Standard Terms and Conditions of Sale apply.

<http://www.greenwichinst.co.uk>

ISSUE 4 OCT 2005

**GR881 (8K x 8)
NON-VOLATILE RAM**

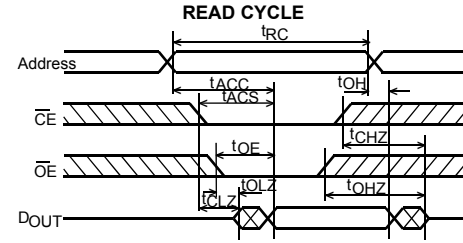

TIMING (nS-nano seconds)

Symbol	Parameter	Min	Max
t _{RC}	Read cycle time	100	
t _{ACC}	Access time		100
t _{ACS}	CE to output valid		100
t _{OE}	OE to output valid		40
t _{CLZ}	CE to output active	10	
t _{OLZ}	OE to output active	5	
t _{OH}	Output hold time	10	
t _{CHZ}	CE to output disable		30
t _{OHZ}	OE to output disable		20

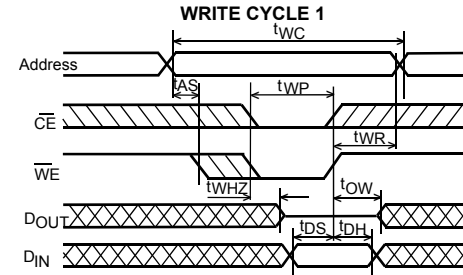

Write Cycle 100nS

Symbol	Parameter	Min	Max
t _{WC}	Write cycle time	100	
t _{WP}	Write pulse width	60	
t _{AS}	Address setup time	0	
t _{WR}	Write recovery time	0	30
t _{WHZ}	WR to output disable		30
t _{OW}	Output active from WR	10	
t _{DS}	Data setup time	40	
t _{DH}	Data HOLD TIME	0	

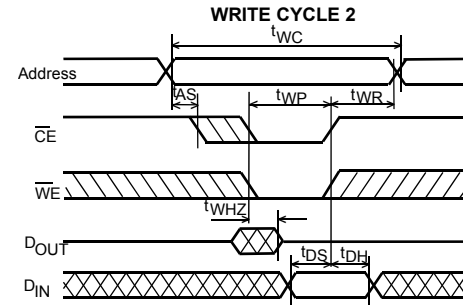

Notes

1. WE must be high during address transitions.
2. A Write occurs during the overlap of active CE and a low WE.
3. CE = CE1 and CE2
4. WE is high for a read cycle.

REPLACES 6264., 5565., etc.

DIMENSIONS (mm)

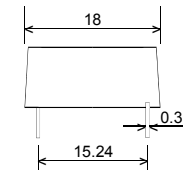
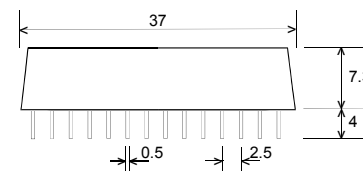

Greenwich Instruments Ltd., are continually developing their products and reserve the right to alter specifications without prior notice. Standard Terms and Conditions of Sale apply.

<http://www.greenwichinst.co.uk>

ISSUE 4 OCT 2005